

FENDT

Fendt 200 Vario





Big in operation.

The Fendt 200 Vario is convincing down the line in the compact standard tractor segment. Experience the unmatched Fendt Vario technology, now available in the 70 to 110 hp maximum output segment, and catch the excitement of continuously variable driving technology and ingeniously easy operation. Fendt has continuously developed this technology – and now Fendt stands for 100 percent Vario.

This compact is always really big

Experience the Fendt 200 Vario, a compact powerhouse, ranging from 70 to 110 hp, that provides advantageous in nearly all areas of application.



More performance:

- Powerful and dynamic drive from 70 to 110 hp with stepless Vario transmission
- Very low fuel consumption
- Efficient cooling system for demanding work

More comfort and safety:

- Optimum shock absorption thanks to front axle suspension with anti-roll control and cab suspension
- Shock load stabilising prevents the tractor and implements from bouncing
- Lower centre of gravity for safe driving on slopes



More versatility

The compact Fendt 200 Vario has high lift capacities and hydraulic capacities for numerous applications. Its straightforward operation makes work easier. Slim lines makes it very manoeuvrable and the low vehicle height enables universal applications with high ground clearance. The Fendt Cargo front loader is an ideal addition to your Fendt 200 Vario.

Big in operation.

	kW	HP
Fendt 207 Vario	51	70
Fendt 208 Vario	59	80
Fendt 209 Vario	67	90
Fendt 210 Vario	73	100
Fendt 211 Vario	81	110

Maximum output to ECE R24

CUTTING-EDGE ENGINE AND TRANSMISSION TECHNOLOGY

Economy and superior efficiency.

Powerful engine – economical fuel consumption

The water-cooled 3-cylinder AGCO Power engine is very compact so that the tractor dimensions could be kept small for the best manoeuvrability. The engine speed-controlled common rail high-pressure injection system and the fully electronic engine control guarantee high performance and a low noise level. The efficient technology allows the Fendt 200 Vario to drive at an economical optimum, which makes it extremely fuel-efficient.

AGRex – economical and environmentally-friendly

The high-performance injection system and the AGRex external exhaust gas recirculation system complement each other. Combustion is optimised through cooling and exact proportioning of recirculated exhaust. In comparison to simple internal exhaust gas recirculation, this significantly lowers fuel consumption and minimises costs per hour.

Superior added value

The continuously variable Vario transmission proves its capabilities in the Fendt 200 Vario. Continuously variable speeds, a sophisticated suspension concept and excellent controls, mean higher working speeds and higher efficiency – all while keeping fuel consumption low.

Precise driving – without steps

You can set the optimum speed independent of the engine speed for any kind of work – stepless from 20 metres per hour to 40 km/h. The ingenious design of the continuously variable Vario transmission enables excellent efficiency, even at high working speeds.

The Fendt Vario transmission is a hydrostatic-mechanical power split drive. With increasing speed, the share of the mechanical power transmitted through the planetary set increases. The hydrostats can be swung 45 degrees and power-splitting via a planetary gear set ensures exceptional efficiency.



Engine characteristics – Fendt 211 Vario

458 Nm torque, 110 hp/81 kW maximum output at 1,900 rpm.

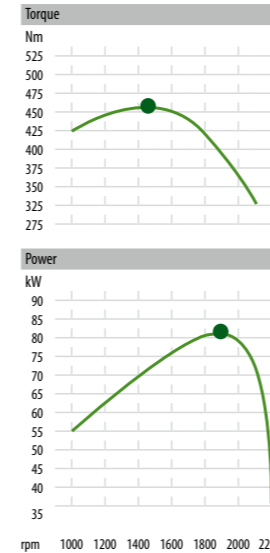

The external EGR system provides targeted cooling of recirculated exhaust, which substantially lowers fuel consumption compared with internal exhaust gas recirculation systems.



The fuel consumption indicator on the Fendt 200 Vario is located in the multi-display. It provides information about the average and current fuel consumption and has two memories. You have full control at all times.



When TMS is activated, the tractor electronics control the engine speed and transmission ratio. Operators only need to set the desired speed, TMS controls the rest. For example, the tractor drives at a reduced engine speed on level ground. On the slope, the load increases, so TMS increases the engine speed and changes the transmission ratio. As soon as the demand for tractive power decreases (on level ground or downhill), the fuel injection quantity is reduced. In this way, high area coverage is effectively combined with fuel-efficient driving.

THE COMFORT CAB ON THE FENDT 200 VARIO

Plenty of space and functionality.

Operate efficiently – drive comfortably

The cab of the Fendt 200 Vario, which was designed specifically for this class, has a cockpit that meets the highest demands. The cab offers an unprecedented amount of legroom and ideal all-round visibility and the best overview. The centralised operating unit on the right-hand side, which integrates all the working and operating functions, and the height and tilt adjustable steering wheel, set new standards in terms of operating ergonomics in this segment.

Comfortable cab

The flat cab floor in the Fendt 200 Vario permits easy climbing in and out and provides plenty of legroom since there is no transmission tunnel. The height and tilt-adjustable steering wheel and the comfort seat with air suspension ensure you are in the right position to stay fit on long working days. The optional cab suspension perfects the high ride comfort.

Perfect working environment – quiet cab

The powerful heating and ventilation system with integral manual of fully automatic climate control guarantees an optimal working climate. The optimum design of the cab keeps the noise level very low.

The generous glass areas and the narrow steering column provide an optimum view to the implements at all times. The roof window provides ideal upward visibility for front loader work.



 The flat cab floor on the Fendt 200 Vario provides unprecedented legroom and makes climbing in and out easy.



 A hinged roof window provides additional ventilation and more upward visibility. The integrated roller shade provides protection against the sun.



 Thanks to the optional suspension, the Fendt 200 Vario cab is optimally supported on the rear axle. Shock loads and vibrations are absorbed by spring elements comprising shock absorbers and lateral stabilisers.

OPERATING CONCEPT FENDT 200 VARIO

Vario operation – easy, faster, better.



Variostick control

The Vario Stick integrates everything in one: a main gear shift lever, range lever and crawler gear lever. The Variostick is ergonomically placed on the right-hand console. With the Variostick, you can accelerate the tractor continuously without any steps between 0.02 km/h and 40 km/h. Push the stick back, the Vario decelerates without steps to a standstill.

Easy to operate and everything in view

Drivers can make all important settings, such as engine speed, cruise control speed, TMS or 4WD and differential lock automatic mode, using the control panel on the right-hand console. The multi-display on the dashboard shows all the information, including fuel consumption, so that drivers have everything in view. For very precise work, the speed can also be displayed from 0 – 2 km/h, accurate to 2 decimal places.

Fast direction changing

Only one hand movement is necessary to change direction. You can change the travel speed easily with your right hand using the Variostick. You can change driving direction quickly and easily with the reverser on the left of the steering wheel, so your right hand remains free to control the hydraulics. This has proven itself particularly useful for front loader work and at the headlands.

Stop&Go function in conjunction with TMS

With the Stop & Go function, drivers can slow the Fendt 200 Vario down to a stop by pressing and holding the switch on the reverser. When the switch is released, the tractor drives in the direction that the switch was actuated.

→ You control the engine speed memory, cruise control and Tractor Management System (TMS) with the clearly laid out key pad.

The height and tilt adjustable steering wheel allows each driver to find the ideal sitting position. Engine speed, multiple and ground speed indicators are found in the instrument cluster.

→ All operating elements have backlighting with night dimming, which makes working in the dark safer.



MANOEUVRABILITY AND FLEXIBILITY

More safety for relaxed work.

Maximum manoeuvrability and stability

The chassis of the Fendt 200 Vario meets the requirements of a compact tractor 100 percent. The wasp-waist design ensures exceptional manoeuvrability and a 52 degree steering angle. Its low vehicle weight guarantees that soil compaction is minimised during operation. The high stability of the Fendt 200 Vario results from the chassis's low centre of gravity. The optimum traction and constant power engagement of the Vario transmission allow you to work safely and without stress, even on slopes.

Powerful hydraulics

The hydraulics on the Fendt 200 Vario have a high oil delivery capacity of max. 48 litres as standard. If a particularly high delivery capacity is required, operators can engage the optional tandem pump for a combined oil flow with a max. delivery capacity of 76 l/min. The separate hydraulic and transmission oil supplies prevent oils from mixing – especially important if hydraulic implements are changed frequently. You profit from the high volume of available oil – 34 litres.

Strong linkage

The optional front linkage has a maximum lift capacity of 2490 daN. Its rugged construction makes it suitable for all kinds of operations. The vibration damping prevents bounce and guarantees safe driving and comfort, even when carrying heavy loads. The electrohydraulic rear linkage with a maximum lift capacity of 4,204 daN guarantees that even the heaviest rear-mounted implements for this power class can be lifted fully.

Three-speed PTO easy to operate

The PTO selector is an electrohydraulic control with 3-speed preselection. The standard PTO automatic mode automatically engages and disengages the PTO, depending on the height of the linkage. The adjustable PTO engagement protects your PTO implements through sensitive start-up control. You profit from low maintenance costs and a longer life for your implements. For special applications, the Fendt 200 Vario is also available with a ground PTO.

 The narrow wasp-waist design enables a wide steering angle of up to 52°, which means outstanding manoeuvrability.

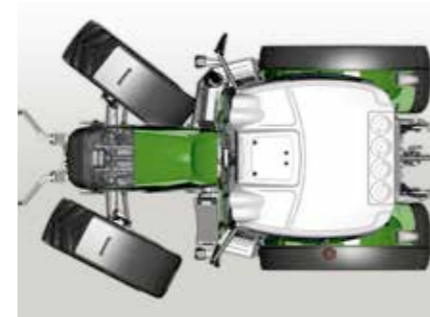

The Fendt 200 Vario can be fitted with pivoting front mudguards as an option. They maximise the wheel angle and permit a turning circle of only 3.98 metres.



With a minimum vehicle height of 2,480 mm with 480/70R30 tyres, the compact Fendt 200 Vario is well-suited for driving into low storage buildings or stables.



The Fendt 200 Vario has external controls for the linkage and rear PTO. Mount rear implements easily and save yourself unnecessary steps, for example, when filling the slurry tank.

TRUE RIDE COMFORT

Stability on all paths.

Exceptional ride and operating comfort

The intelligent combination of three systems guarantees maximum ride and operating comfort: the self-levelling front axle suspension with anti-roll control, the cab suspension and the active shock load stabilising. This reliably minimises shock loads and counteracts uneven ground on the road and in the field. Self-levelling permits high payloads and ensures a constant, high degree of suspension comfort even with high loads.

Constant driving speeds thanks to cruise control

The standard cruise control makes driving at a constant speed child's play. Two speeds can be stored in the instrument cluster, for example, one for in the field and one for on the road. The cruise control activation button is conveniently located under the Variostick. You can reach it with your thumb, without having to take your hand off the speed control lever.

Front axle suspension

The front axle, which is pushed by the torque tube, detects uneven surfaces and transmits these findings to hydraulic cylinders. The oil displaced in the cylinders presses against the nitrogen reservoirs, where the shock loads are dampened. The integral automatic self-levelling with position sensor guarantees constant suspension comfort independent of load. Anti-roll control guarantees a high degree of stability and operating safety, especially when working with mounted implements on slopes.

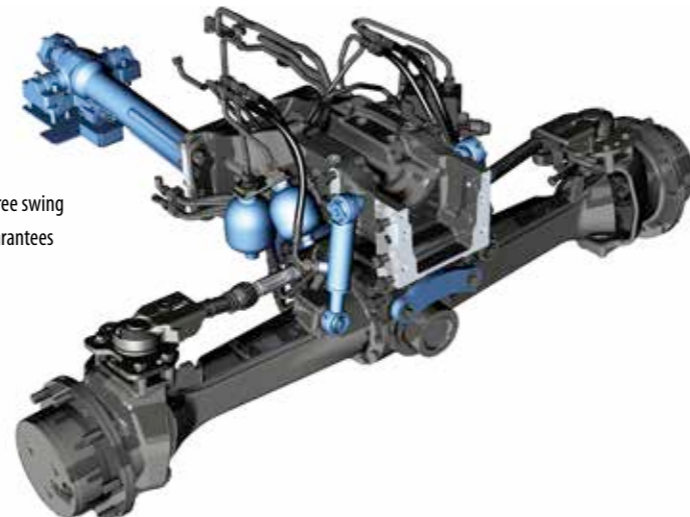

 The front axle suspension has a total suspension travel of 90 mm along with a 20 degree swing angle. Self-levelling maintains suspension comfort, independent of payload. That guarantees safe braking and steering of the vehicle at all times.

The shock load stabilising system works like an electronic shock absorber when driving with rear-mounted implements on the road and in the field. This allows quiet, fast and safe driving without annoying vibrations.

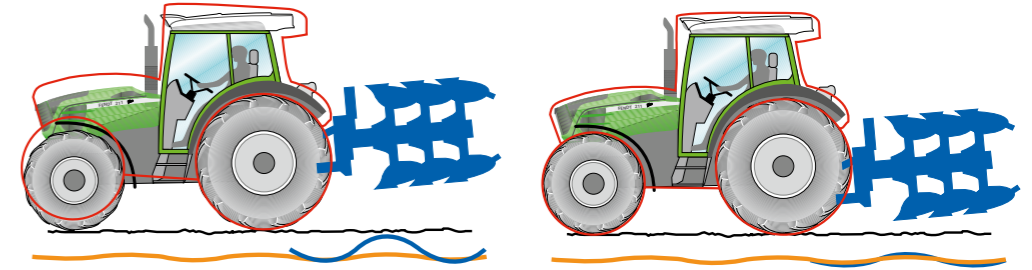

THE FENDT OVERALL PROFITABILITY

Invest right – and keep on saving.



Efficient from tractor up to fleet

It is clear that you get cutting-edge technology with a Fendt tractor. However, there is much more to the overall cost picture of a Fendt Vario: from competent consultation, to comprehensive services up to the exceptional value retention of a Fendt tractor.

Fendt overall profitability

- Fendt Efficiency for the best cost-effectiveness per hectare
- Fendt Comfort for pleasant working conditions day after day
- Fendt Retention of Value for an unbeatable resale value
- Fendt Service for competent consultation and full reliability
- Fendt Flexibility for custom financing and individual offers
- Fendt Expert driver training for highly efficient Vario driving

Long-term economy

High efficiency reflects itself in a higher yield and lower use of inputs such as fuel, operating inputs or time. The Fendt 200 Vario continues in the tradition of its predecessor and delivers high performance at low engine speeds – so there is less wear on all the components and diesel and AdBlue consumption is reduced. Its high overall profitability pays off during every operation.

100% quality, 100% service: Fendt StarService

To ensure that your Fendt 200 Vario delivers 100 percent performance at all times, we offer 100 percent service. In addition to the best diagnostics-capability and ease of repair, this includes availability of replacement parts 24/7 during the season. Furthermore, the Fendt Service network guarantees short paths between you and our trained Service staff. You also get a 12-month warranty on original Fendt parts and their installation. Repairs with original parts ensure that your Fendt tractor retains its value.

Individual financing and rental models

Purchasing machinery is a high capital investment. Your Fendt dealer will assist you in working out a customised financing plan for your new machine together with the agricultural financing experts at AGCO Finance. If you have a short-term need for additional capacity or prefer long-term use without having to buy, your Fendt sales partner has the ideal rental offer for you.



The best product, the best services: Certified Fendt dealers are distinguished by their first-class expertise and their comprehensive range of services. They regularly undergo strict audits to prove their high-quality of service. Your Fendt is in the best hands here.

With the smartphone app "AGCO Parts Books to Go", you can find and directly order Fendt replacement parts quickly and easily. The app is available through the App Store or the Google Play Store. Please contact your Fendt dealer for your personal access data.

VARIO AND CARGO FRONT LOADER

The tailor-made design.



A multi-coupler connects all hydraulic and electric lines at once – even under pressure on the front loader side. The front loader can be quickly mounted and removed.

With the Fendt Cargo Lock, you can mount and remove the Cargo front loader from your Fendt 200 Vario even faster and easier. Thanks to the semi-automatic lock, you no longer need to insert locking bolts, which is often difficult. The system also offers optimum operational safety, since the front loader is locked in place immediately after driving into it.

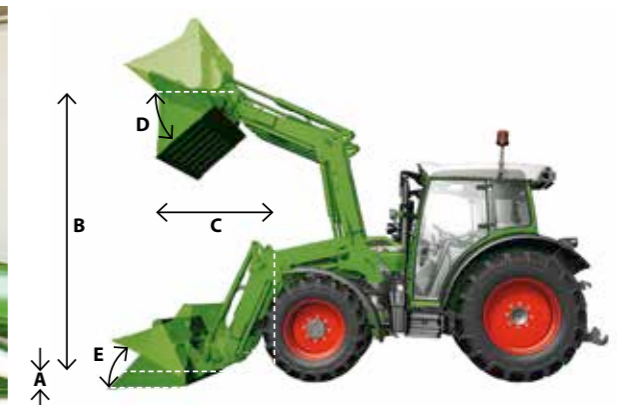

	Fendt front loader	Cargo 3X/65
A	Continuous lift capacity	daN 1,680
B	Maximum lift capacity	daN 1,850
C	Lifting height	mm 3,740
D	Digging depth	mm 210
E	Dumping dist. (B = 3.5 m) ¹⁾	mm 1,170
F	Dumping dist. (B = max.) ¹⁾	mm 860
	Angle of emptying	° 55
	Angle of backwards tilt	° 48

¹⁾ depends on tyres

Front loader to Fendt standards

Fendt offers the Fendt CARGO 3X65 front loader exclusively for the Fendt 200 Vario. This front loader is also "Made by Fendt". An in-house development, the Fendt front loader has been ideally adapted to the Fendt 200 Vario tractor range. The front loader 3X65 unites all the advantages of Fendt Cargo and convinces through compactness and easy handling. Comfort, safety and service-friendliness also meet the high Fendt standards.

Fit together perfectly

The Fendt 200 Vario and the Fendt Cargo 3X65 build a perfect unit. From the very beginning, all the dimensions and forces of the Cargo were explicitly adapted to the compact Fendt 200 Vario. The results are high operational safety and the best visibility along with balanced distribution of forces and loads. A specially designed connection between the front loader and the tractor permits all maintenance work to be performed while the front loader is attached.

Handling at its best

The operating concept was designed for optimum driving comfort. The standard crossgate lever provides precise control of the Fendt Cargo. If you require the optional third, or even a fourth, hydraulic circuit, you can operate them via push-buttons on the crossgate lever.

Ideal damping system

The Fendt Cargo front loader has an ideal damping system. Gas pressure reservoirs absorb vibrations and shock loads so they are not transmitted to the tractor body. The complete damping system, in combination with the front axle and the cab suspension, is coordinated for the best comfort.

FLEXIBLE AND PRACTICAL

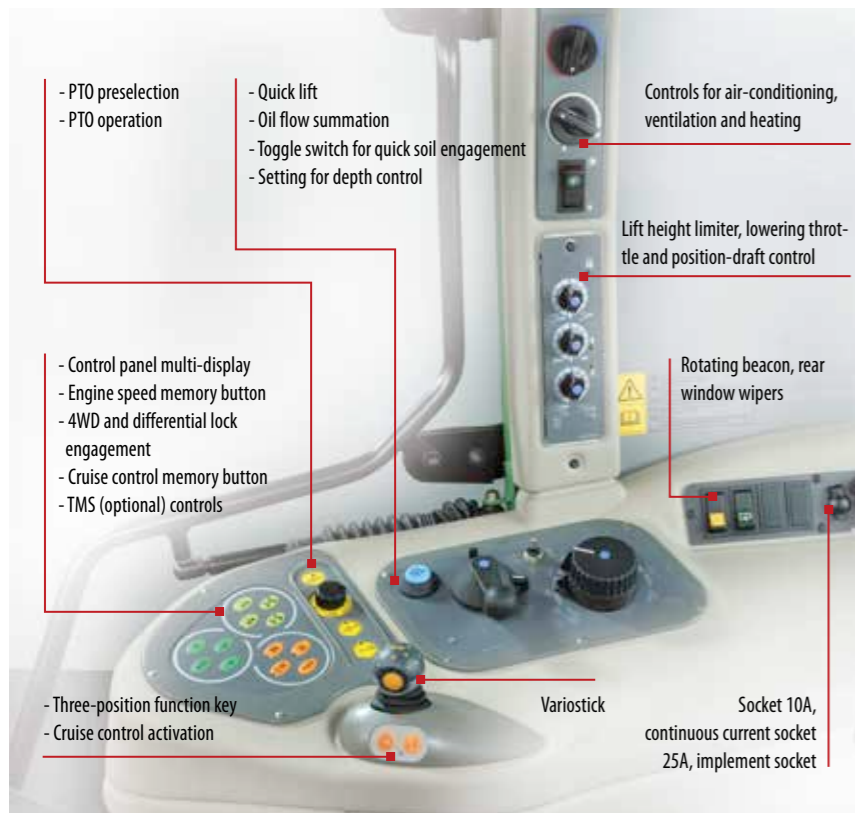

□ With the reverser lever, changing directions is easily done with the left hand.



■ The crossgate lever controls Valves 1 and 2 very precisely.

EQUIPMENT VARIANTS

Fendt 200 Vario. Big in operation

Cab	Variostick control	■
	Height and tilt-adjustable steering column	■
	Hot water heating with inf. adj. blower	■
	Comfort seat with air suspension	■
	Hinged front / rear windows	■
	Roof window, hinged, with roller shade	■
	Self-cancelling indicators	■
	Active charcoal filter	□
	Integrated air conditioning	□
	Automatic climate control	□
	Rear working lights	■
	Additional lights, front (integral)	□
	Telescoping rear view mirror	■
Socket for electr. speed signals	■	
Mechanical cab suspension	□	
Radio CD MP3 with hands-free speaking system	□	
Radio MP3	□	
Battery disconnect	□	
Engine	Water-cooled turbo engine	■
	AGReX external exhaust gas recirculation	■
	Integrated air filter pre-cleaner	■
	Automatic cold-start	■
	Engine preheater	□
Transmission	Turboclutch function	■
	Cruise control, maximum output control 2.0	■
	TMS – Tractor Management System	□
	Reversing gearbox, Stop&Go function (with TMS)	□
	Acoustic signal when reversing	□
Chassis, driving safety	Front axle suspension self-levelling, lockable	□
	Shock load stabilising, electro-hydraulic linkage control	■
	Compressed air system	□
4WD differential locks	Comfort controls 4WD/differential locks speed and lift height controlled	■
	Automatic front differential lock	■
	Rear differential with disc locking	■
	Fully protected drive shaft	■

PTO	Rear 540/540E/1000 rpm	■
	Rear 540/ground/1000 rpm	□
	Front 540 rpm or 1000 rpm	□
	PTO engagement control, electrohydr. preselection	■
External controls for rear PTO	■	
Hydraulics	Hydraulic single pump, hydraulic oil cooler (max. 48 l/min)	■
	Hydraulic twin pump, hydraulic oil cooler (max. 76 l/min)	□
	Hydraulic valve actuation crossgate lever	■
External controls for rear linkage	■	
Linkage	Electrohydraulic power lift control EPC with shock load stabilising	■
	Quick coupler	■
	Front linkage	□
Body	Rear hitch	■
	Automatic hitch with remote control, rear	□
	Ball-type coupling, height adjustable	□
	Pickup hitch	□
	Swinging drawbar	□
	Piton fix	□
Beacon left	□	
Pivoting front wheel mudguard	□	
Front weights, various sizes	□	
Ballast weights for rear wheels	□	
Front loader	Front loader attachment parts	□
	Front loader Cargo 3X/65	□



□ The Fendt 200 Vario can be fitted with cab suspension as an option. The cab rests on conical rubber bearings at the front, so that it is isolated from vibrations emanating from the tractor body. The helical spring shock absorber system at the rear of the cab reduces shock loads to a minimum.



The following interfaces are available:

- Signal socket
- Hydraulic or mechanical top link
- Lower links with catch hook
- Linkage lock
- Ball holder
- Double-acting control valves
- Unpressurised return rear
- Compressed air brake
- Hydraulic trailer brake
- 7-pin socket
- Hitch
- Rear PTO



Interfaces at the front:

- Top link
- Lower links with catch hook
- 7-pin socket
- Front PTO

Standard and optional equipment
 Standard: ■
 Optional: □

FENDT 200 VARIO

Technical Specifications.



Fendt 200 Vario		207	208	209	210	211		
Engine	Rated speed ECER24	kW/hp	51/70	59/80	67/90	73/100	81/110	
	Rated power EC 97/68	kW/hp	28/38	30/41	32/44	34/46	36/49	
	Maximum power (kW/hp) (EC 97/68)	kW/hp	55/75	63/85	70/95	77/105	85/115	
	No. of cylinders/cooling		3/water	3/water	3/water	3/water	3/water	
	Bore/stroke	mm	108/120	108/120	108/120	108/120	108/120	
	Cubic capacity	cm ³	3300	3300	3300	3300	3300	
	Rated engine speed	rpm	2200	2200	2200	2200	2200	
	Speed at max. power	rpm	1900	1900	1900	1900	1900	
	Max. torque	1600 rpm	295	337	373	408	458	
	Torque rise	%	35	32	30	30	44	
	Opt. fuel consumption	g/kWh	212	212	210	210	210	
	Fuel tank capacity	Litres	125	125	125	125	125	
	Oil change interval	hrs	500	500	500	500	500	
Oil change interval	hrs	500	500	500	500	500		
Transmission and PTO	Type	Stepless Vario transmission						
	Speed range (forward / reverse)	0.02 to 40 km/h / 0.02 to 25 km/h						
	Maximum speed (km/h) ²⁾	km/h	40	40	40	40	40	
	Powershiftable rear PTO standard – optional	540 / 540E / 1000 – 540 / ground / 1000						
	Engine speed for rear PTO rated speed	540 and 1000 rpm PTO: 1900 rpm 540E PTO: 1560 rpm						
Front PTO (rpm) ¹⁾	U/min	540 or 1000						
Hydraulics	Type	Electrohydr. linkage control (EHR) with shock load stabilising						
	Control	Free floating, position, draft and inf. adj. mix control						
	Hydraulic pump capacity	l/min	single pump (48 l/min); tandem pump (35 l/min + 41 l/min) ¹⁾					
	Working pressure	bar	200	200	200	200	200	
	Auxiliary control valves, max. centre/rear		2/4	2/4	2/4	2/4	2/4	
	Max. available oil volume	Litres	34	34	34	34	34	
	Flow volume control valves	1st valve: 5-65 litres, 3rd valve with 5-65 litres ¹⁾						
	Max. lift capacity, rear linkage	daN	4204	4204	4204	4204	4204	
Max. lift capacity, front linkage ¹⁾	daN	2490	2490	2490	2490	2490		
Brakes	Rear brakes	wet ring piston brake						
	Four-wheel braking system for 4WD	automatic 4WD engagement						
Weights and dimensions	Unladen weight with cab	kg	3750	3790	3870	3870	3930	
	Max. perm. overall weight	kg	7000	7000	7000	7000	7000	
	Max. hitch load	kg	2000	2000	2000	2000	2000	
	Overall length	mm	4068	4068	4068	4068	4068	
	Overall width	mm	1970	2170	2170	2170	2186	
	Wheelbase	mm	2294	2294	2294	2294	2294	
	Min. turning circle to ISO 789/3 w/o steering brake with track 1700 mm	m	3.98	3.98	3.98	3.98	3.98	
	Overall height comfort cab	mm	2480	2480	2530	2530	2530	
	Max. ground clearance	mm	475	475	475	475	475	
	Track width front	mm	1500	1500	1690	1690	1690	
	Track width rear	mm	1510	1660	1660	1660	1660	
	Tyres front	320/70 R 24		■	■	□	□	□
		380/70 R 24		□	□	■	■	□
440/65 R 24			□	□	□	□	■	
270/80 R 32			□	□	□	□	□	
425/75 R 20			□	□	□	□	□	
Tyres rear	420/85 R 30		■	□	□	□	□	
	480/70 R 30		□	■	□	□	□	
	480/70 R 34		□	□	■	■	□	
	540/65 R 34		□	□	□	□	■	
	270/95 R 44		□	□	□	□	□	
	600/65 R 30		□	□	□	□	□	

1) Upon request 2) Speed depends on tyres

FAQ. EVERYTHING ABOUT FENDT

What can we do for you?

What makes Fendt Service different?

For us, service means knowing and understanding your work in order to meet your demands for reliability and safety and to act in your economic interest. We stand behind our products and have developed them for the highest demands and long-term operation. Our service is the partnership aspect for your work.

What is Fendt Expert?

Become a Vario pro with Fendt Expert driver training: Are you already familiar with all the functions that the technology has to offer? Take advantage of the technology that is found in every Fendt Vario and learn how to optimise the use of all the features with Fendt Expert. Our team of professional instructors offers you competent instruction to enable you to exploit the full performance potential of your Fendt tractor. Inform yourself through your dealer and sign up.



Contact to Fendt.

fendt.com

Here you will find everything online, from brochures to technical specifications, reports about customers or the company, up to the Fendt event calendar.

fendt.tv

Fendt around the clock – our Fendt Media Library makes it possible. Our internet TV provides you with news and information about Fendt 24/7.

Fendt Configurator

With the Fendt Vehicle Configurator, you can choose from all the available equipment variations and put together the optimally equipped vehicle for your farm. The Fendt Configurator is available online at www.fendt.com, where you will find a quick link to it directly on the start page.

Test drives

At fendt.com, you will find the area Service and Sales under "Fendt World". Select the "tractor demonstration service", then you can already register for a test drive with a tractor.

facebook.com/FendtGlobal

Over 200,000 fans have already friended Fendt on Facebook. Come have a look.



FENDT SPOTLIGHT.
 NOTABLE. BETTER.

This symbol stands for solutions that offer special benefits for your daily work and make a Fendt a Fendt.

FENDT

Leaders drive Fendt.



www.fendt.com

AGCO GmbH – Fendt-Marketing
87616 Marktoberdorf, Germany

 **AGCO**
Your Agriculture Company

Fendt is a worldwide brand of AGCO.
All data regarding delivery, appearance, performance, dimensions and weight, fuel consumption and running costs of the vehicles correspond with the latest information available at the time of going to press. Changes may be made before the time of purchase. Your Fendt dealer will be pleased to supply you with up-to-date information. Vehicles are not shown with country-specific equipment.